



ENER-CAP® II & ENER-CAP II HP

High-performance Bidirectional Seal

SELF-ACTUATING, PRESSURE-ACTIVATED

The Greene, Tweed Ener-Cap® II is a self-actuating, pressure-activated hydraulic seal that optimizes cap seal performance within standard Aerospace seal glands. The Ener-Cap II HP includes one or two anti-extrusion rings to give higher pressure capabilities by preventing extrusion of the PTFE sealing element. The cap seal design results in low breakout and running friction and minimal leakage over an extended service life, making this seal design ideal for dynamic service.

The PTFE-type sealing element and advanced-design elastomeric energizer provide optimum radial squeeze and evenly distributed radial loading. This design gives a high degree of seal stability and extended service life. Our Avalon® materials offer exceptional performance. A custom-molded energizer ensures correct squeeze levels are maintained. The addition of circumferential cap grooves will improve the lubrication and reduce outboard leakage.

Operating temperatures can range from -80°F to 450°F (-62°C to 232°C) with pressures to 4,000 psi (276 bar), dependent upon the selected materials and hardware clearances. The Ener-Cap II HP extends the working pressures significantly and operates successfully at above 8,000 psi (550 bar).



**Ener-Cap II
Piston**

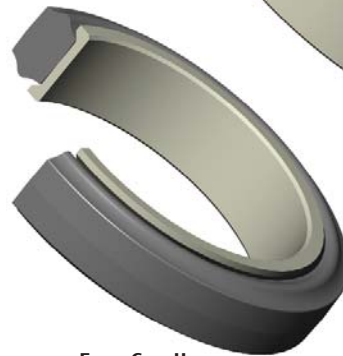

**Ener-Cap II
Rod**



**Ener-Cap II HP
Double-Acting Piston**



**Ener-Cap II HP
Double-Acting Rod**



FEATURES & BENEFITS

- Capable of sealing pressures up to 4,000 psi (276 bar) without backups, easing installation of other multi-component seals
- Specially designed elastomeric energizer supports even sealing force distribution promoting better sealing performance
- Low break out and running friction
- Long life and low friction of the Avalon® material extend service life
- Retrofits existing gland to the MIL-G-5514/AS4716 standards

Ener-Cap® II Installed

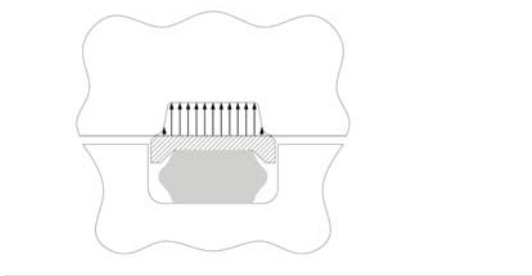

Ener-Cap II Pressurized

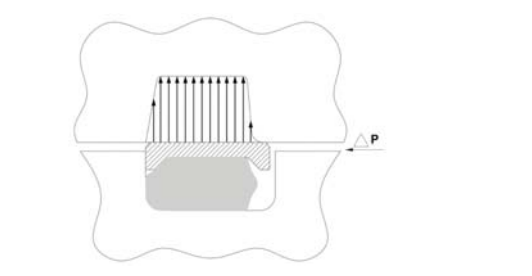

APPLICATIONS

- Primary and secondary flight controls
- Linear utility actuators
- Accumulators/reservoirs
- Landing gear actuation systems

ENER-CAP II CONFIGURATIONS

The Ener-Cap II is available for rod or piston applications in standard zero back-up, one back-up or two back-up width glands per MIL-G-5514/AS4716.

Gland Dimensions

Rod

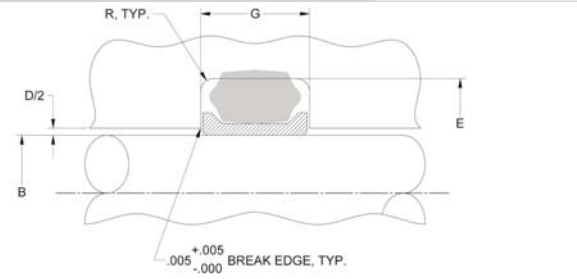

Piston

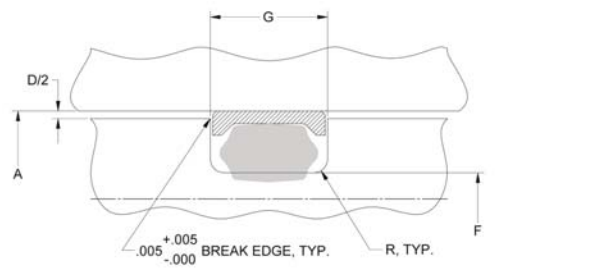

Note: Refer to the dimensional tables for more information.

Ener-Cap II with Wedge Adapter

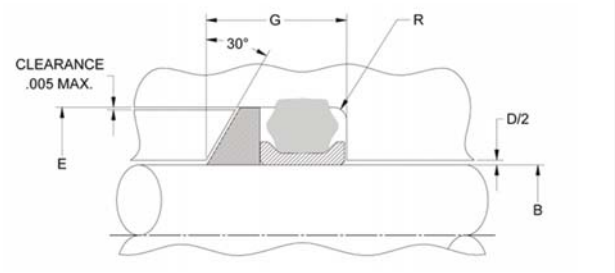

Note: Custom configurations are available to suit BACS11AA. Contact GT engineering for more information.

ENER-CAP® II OPTIONS

Notches—Blow By Protection

Both piston and rod type 52 series Ener-Caps can be supplied with notches for blow by protection, in accordance with SAE AIR 1243.

Notches

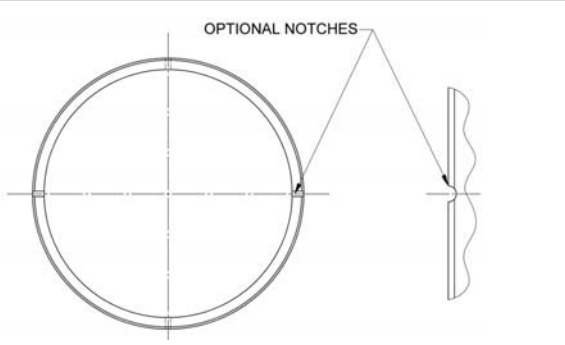

Circumferential Grooves

Circumferential grooves can be added to the 52 series piston and rod Ener-Caps to provide for better dynamic sealing (except for the smaller -0XX sizes). The grooves will retain lubricant that enhances start-up performance by releasing the lubricant to the sliding surfaces as the surface moves.

Grooves

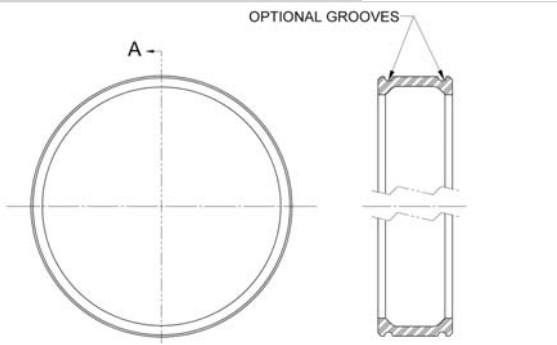

ENER-CAP II HP OPTIONS

Greene, Tweed has designed the 5279 series of Ener-Cap II HP to combine the long-life, low-friction properties of the Ener-Cap II with the high shear strength back-up capabilities of a back-up ring. This allows the seal to be used at pressures in excess of 4000 psi (276 bar). The Ener-Cap II HP is available for rod and piston applications in standard one back-up and two back-up glands only.

Contact GT engineering for specific part numbers.

Ener-Cap II HP

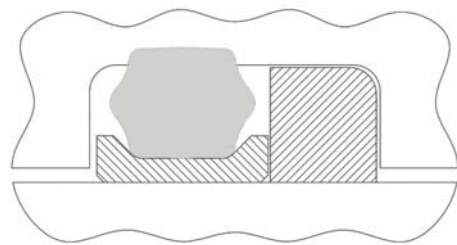

Ener-Cap II HP Bidirectional

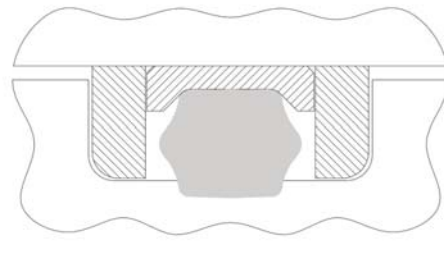

ENER-CAP® PART NUMBERING SYSTEM

The part numbering system requires the use of the material designator tables found in the next column. For nonstandard designs contact GT engineering.

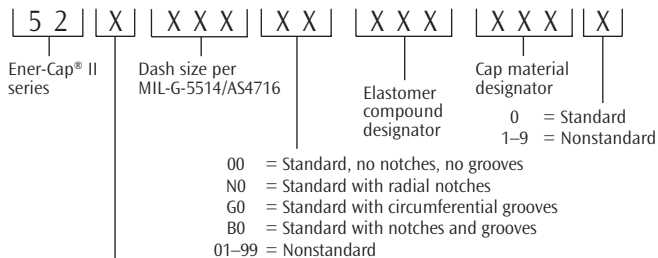

ROD	PISTON	GLAND WIDTH
1	2	Zero back-up gland width
3	4	One back-up gland width
5	6	Two back-up gland width

Part Numbering Examples

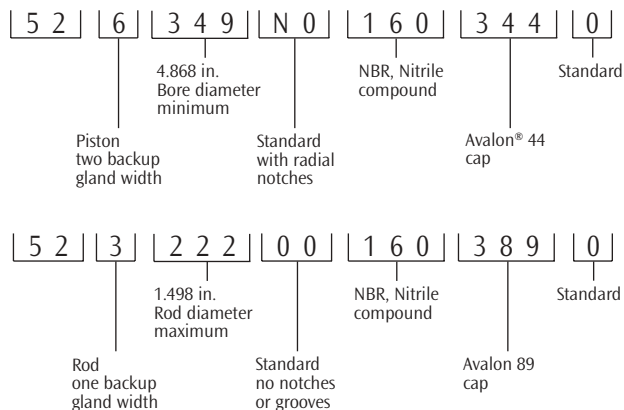

Contact your local Greene, Tweed representative for specific recommendations to suit higher performance requirements.

Ener-Cap 59 Series

The original Ener-Cap design, 59 series, has been replaced by 52 series Ener-Cap II for all new applications.

Material Designator Tables

CODE	ELASTOMER COMPOUND
160	NBR, Nitrile
161	NBR, Nitrile
409	FVMQ, Fluorosilicone
731	FKM, Fluorocarbon
772	FKM, Fluorocarbon
952	EPM, Ethylene Propylene
954	EPDM, Ethylene Propylene
964	NBR, Nitrile

CODE	CAP MATERIAL
043	Avalon 07
019	Avalon 09
344	Avalon 44
069	Avalon 50
357	Avalon 57
389	Avalon 89

See GT Surface Finish guidelines.



Contact Us

Greene, Tweed & Co. Tel: +1.215.256.9521
Aerospace Tel: +1.800.220.4733
Kulpsville, PA, USA Fax: +1.215.513.9411

www.gtweed.com

Statements and recommendations in this publication are based on our experience and knowledge of typical applications of this product and shall not constitute a guarantee of performance nor modify or alter our standard warranty applicable to such products.